

New generation barrier **PAB-BD BEYOND** adopts free-maintenance DC brushless torque motor and PWM variable frequency servo controller, fast but smooth moving. Incredible 10 million MTBF and 100% duty cycle makes it continuously work at 7*24 hrs with long life span. Its boom direction is exchangeable, boom type can be changed at site without replacing any parts. Open/close time 0.9~6s adjustable, Max.6m boom. It can be controlled by smart phone via WIFI and by PC via TCP/IP.

Smartphone Control Your Barrier (Optional)

The barrier gate can be connected to your smartphone via WIFI, so you can open and close barrier gate on your smartphone. You can also program the barrier on your smartphone such as setting opening/closing time.

*Dashou App should be installed in your smartphone, and Dashou WIFI module should be installed in barrier controller.

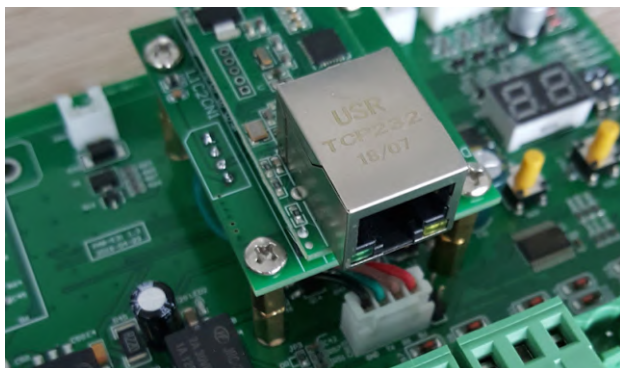

TCP/IP RJ45 Port for Easy Integration (Optional)

The barrier provides optional TCP/IP RJ45 port, which can integrate the barrier with your own system conveniently, so you can control the barrier by your own system. You can even remotely monitor the status of barrier.

*Dashou Ethernet module should be installed in the controller, and communication protocol will be provided by Dashou

Free-maintenance DC Brushless Servo Motor 10 million cycles MTBF & 100% duty cycle

Free-maintenance DC24V brushless servo torque motor ensures 10 million cycles MTBF long life span; 100% duty cycle makes barrier continuously work at 24*7 hours; Max. 50W super low consumption makes barrier environment friendly but outputs super strong torque

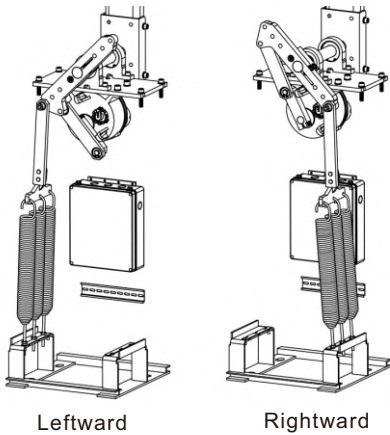

Boom Direction Is Exchangeable Without Replacing Any Parts

In the past you have to keep stock for barriers with different boom direction as different sites may require different boom direction. But now boom arm direction can be exchanged easily at site without replacing any parts

Automatically Check Status and Report Error

Barrier system will automatically check its operation status and show errors code on its LED tube if an error occurred. This helps you quickly find out problem and find solution.

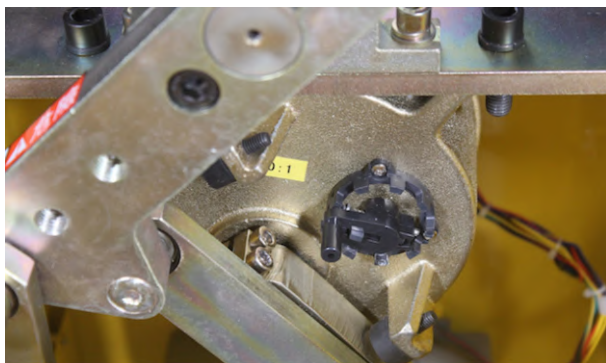
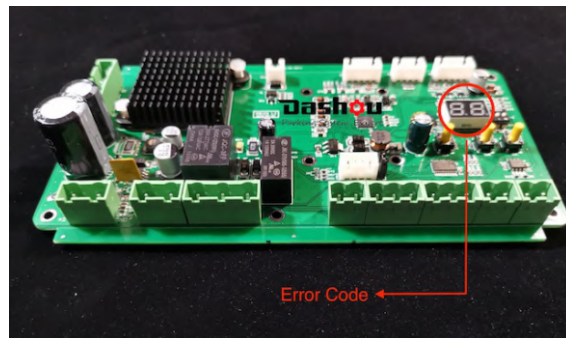

Manually Control In Case of Power Failure

If power supply is off, you can manually open/close the barrier gate by the black lever. Also boom can be manually locked in any position between horizontal and vertical by this level.

Warning: Not allowed to use the function when power on, may hurt your hand and damage the motor.

Boom Auto-Reverse On Obstacle

While moving down, boom will automatically reverse immediately once it is obstructed by vehicle or pedestrian, which protects the vehicle or person. The sensitivity is adjustable.



Boom Swing-off Protects Boom and Vehicle

Boom will swing off 90 degree if it was hit by a vehicle, this is to protect both vehicle and boom. It is optional. You can easily add swing-off module to a barrier which is without swing-off.

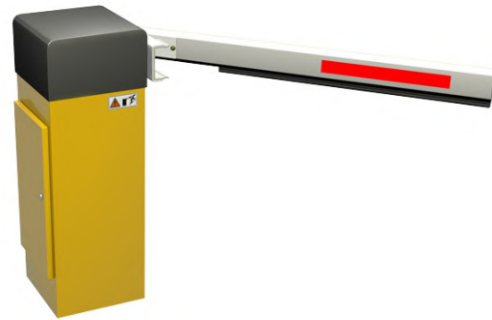

Backup Solar Panel or Lead-acid Cell

DC motor barrier can be powered by solar panel or lead-acid cell for back up power supply. Especially solar power is environment friendly which is good for earth.

LED Illumination Makes Boom Visible In The Night

LED Illumination bar can be installed onto boom to make boom visible in the night, so that drivers can view barrier and boom clearly, this improve safety of both barrier and vehicle. Also LED decorates barrier gate.



More Features

1. 0.9~6 sec. speed adjustable on controller or APP (If WIFI Module is connected and APP is installed in smartphone)
2. Quite smooth moving with Max. 6m boom
3. Different types of boom can be changed without replacing any parts
4. Variable frequency controller automatically detects and optimizes boom moving, ensures smooth moving without shake
5. Simplified design, easy installation and maintenance reduces your labor cost
6. Boom automatically open up fully in case of power failure (Optional)
7. Boom will be automatically locked in case of power failure (Can not work together with function 6 at the same time)
8. Alarm when boom swing-off (Optional)
9. Safety of Vehicle--- Anti-hit by Loop Detector (Optional)
10. Safety of Vehicle--- Anti-hit by IR photocell (Optional)
11. Safety of Vehicle--- Anti-hit by "Opening Priority"
12. Closing Priority
13. Automatically close in given time (Programmable)
14. Automatically close or open by loop detector (Optional)
15. Disable/enable function of "Always-open Mode of remoter" on controller
16. Disable/enable function of "Memory of Repeated Opening"
17. Heavy-duty and simple-design housing
18. Anti-condensation in cold climate
19. Transparent plastic covers on control board

Dimension (mm) Application

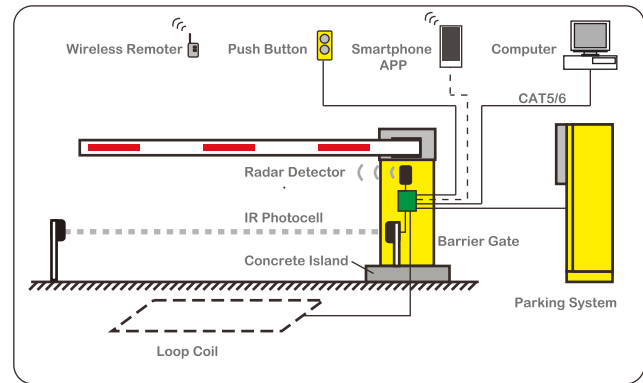
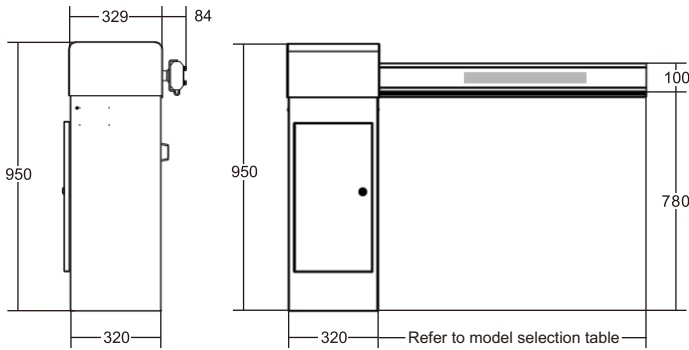

Technical Parameter

Close/open time	0.9~6 sec. adjustable
Boom	Max. 6mtr. 45×100mm Aluminum alloy Octagonal boom
Boom	Max. 3.5mtr. round boom with foam
Boom Direction	Leftward / rightward exchangeable
Power Supply	AC 100~240V, 50-60Hz, Max. 0.65A
Motor	50W DC24V brushless servo torque motor
Duty Cycle	100% duty cycle
MTBF	10 Million Cycles (Meantime Before Failure)
Controller	PWM variable frequency servo controller board
Wireless Remote	Two Remoters, distance>20m

Communication Interface	RS-485 or TCP/IP RJ45
Loop detector Input	Pulse width > 100ms
Housing Material	2mm cold-roller sheet
Housing Painting	Powder coating last 10 years
Protection Rating	IP 54
G.W / N.W	46/44KG
Package Dimension	1100×480×430mm
Dimension	950×320×329mm (H*W*D)
Operating Temperature	-40°C~75°C
Operating Humidity	10%~95%

Accessories

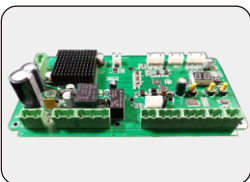

PWM variable frequency servo controller board



Remoter: transmitter, distance>20m

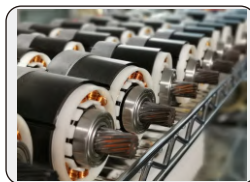

50W DC24V Brushless Servo Torque Motor

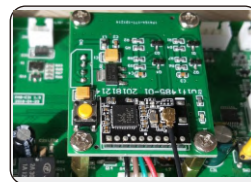

WIFI Module Smartphone control barrier

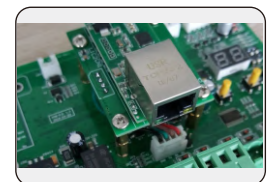

Ethernet Module Make your system control our barrier



Aluminum Alloy Round Boom with Foam



45×100mm Aluminum Alloy Octagonal Boom with Rubber Bar

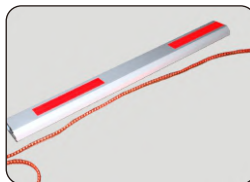

Arm With LED light bar: Green/red, DC12V power

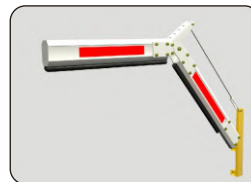

Crank arm



Fence arm



Boom Arm Bracket

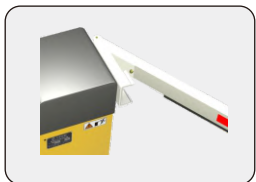

Swing-off



Ground Induction Coil



Loop Detector



Photocell